

SWITCH
LOGIQ



TEM

TEM

SWITCH
LOGIQ

VSEPRISOTNA SAMOZAVEST Narejen za vsak prostor

Oblika, ki je doma v vsakem prostoru. Univerzalne linije stikal pustijo svoj pečat v modernih delovnih okoljih ali v bolj domačih toplih bivalnih prostorih. Za vsako vašo željo vam družina stikal LOGIQ ponuja preprosto in logično rešitev.

OMNIPRESENT CONFIDENCE made for every room

A shape for every room. The switches have universal lines that leave a mark in both modern work environments as well as in cosy, comfortable living spaces. The LOGIQ family offers a simple and logical solution for your every wish.



HARMONIJA BARV Izberi svoj odtenek

Družino LOGIQ odlikuje logičen izbor preverjenih in elegantnih barvnih odtenkov, ki jih imajo uporabniki najraje. Ne prilagajajte se vi, linija LOGIQ se prilagaja vam, zato vam vedno lahko izdelamo tudi barvni ton, prilagojen vašim posebnim željam. Logično.

HARMONY OF COLOURS Choose your hue

The LOGIQ family prides itself on its logical range of verified and elegant hues known and loved by our clients. Don't compromise, the LOGIQ family has you covered. We can always create the hue of colour in accordance with your special request. Logically.

■ **antracit /**
anthracite

■ **titan /**
titanium

■ **bela-sijaj /**
polar white



NEOMEJENA DOMIŠLJIJA

Sestavi svojo kombinacijo

LIMITLESS IMAGINATION

Create your own combination

Družina LOGIQ omogoča sestavljanje poljubnih kombinacij. Za enostavno kombiniranje smo za vas izdelali uporabno dopolnitev, ki vam bo olajšala nizanje vodoravnih in navpičnih linij. Tako imenovani sistem 55/55 vam omogoča, da lahko vselej uporabite iste univerzalne elemente. Že veste, česa si želite? Ne skrbite, stikala LOGIQ berejo vaše misli.

The LOGIQ family allows you to create your own combination. To make combining simple, we have created a useful system that supports the sequencing of horizontal and vertical lines. The so-called 55/55 system allows you to use the same universal elements every time. Know what you want? Don't worry, the LOGIQ switches can read your mind.



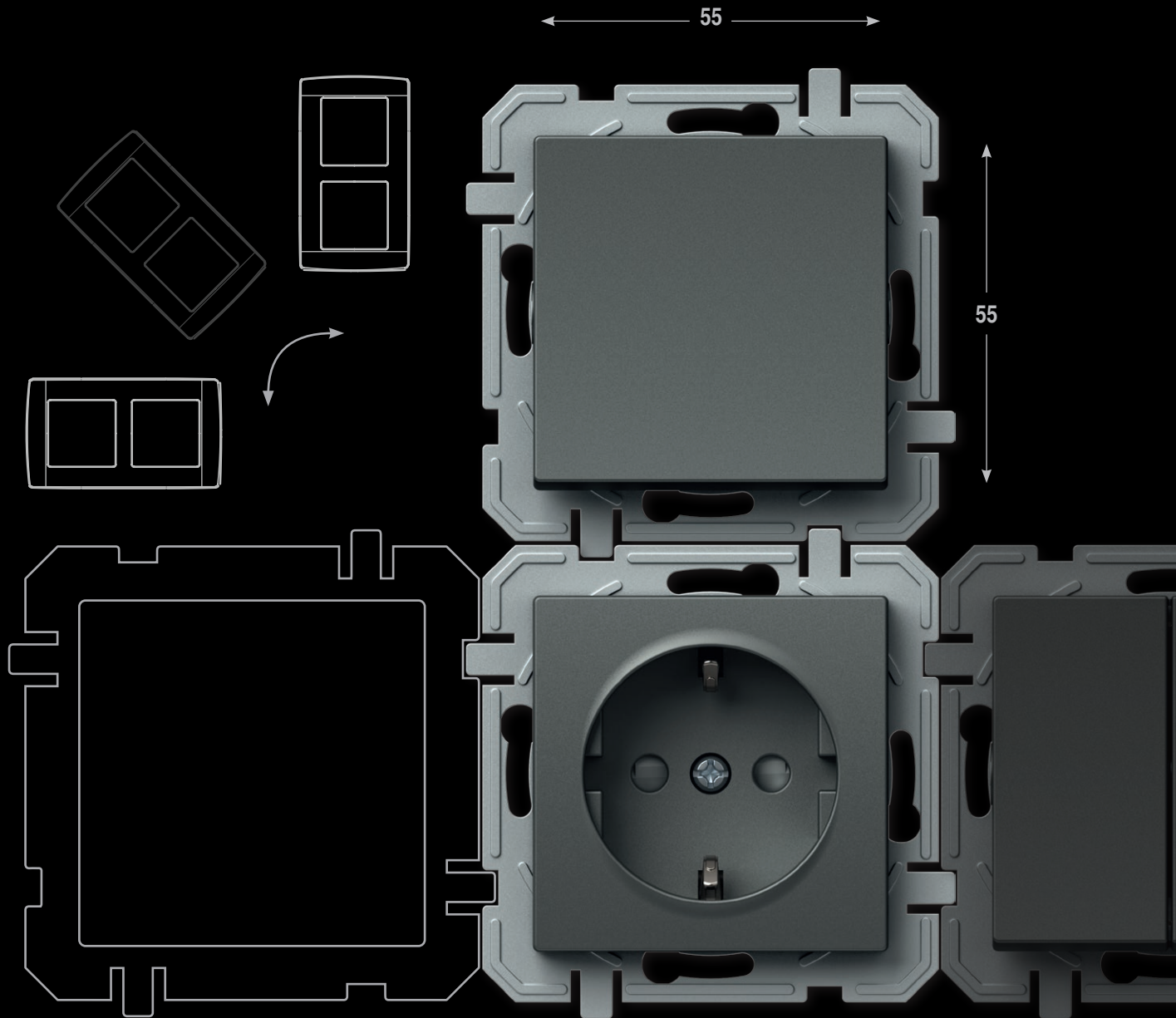

PREPROSTO ZA NAJZAHTEVNEJŠE

Družina LOGIQ so stikala, regulatorji, senzorji, vtičnice za vsak namen in vse na enem mestu. Lahko jih uporabite posamično ali v nizu. Kot vsaka družina, ki raste in se razvija, bomo tudi našo ponudbo razvijali naprej, skladno z vašimi potrebami in željami. Radi vam prisluhnemo in vam ponudimo rešitev, ki bo enostavno in logično nadaljevanje zgodbe družine LOGIQ.

SIMPLE FOR THE MOST DEMANDING

The LOGIQ family offers switches, regulators, sensors, and sockets for every purpose in one place. You can use these products individually or in a sequence. Just like every family that grows and develops, the LOGIQ family will continue to develop our range of products in accordance with your needs and wishes. We are happy to listen to you and offer a solution which will simply and logically continue the story of the LOGIQ family.

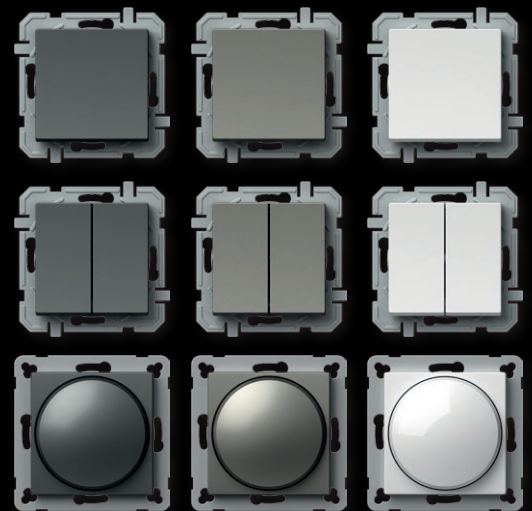

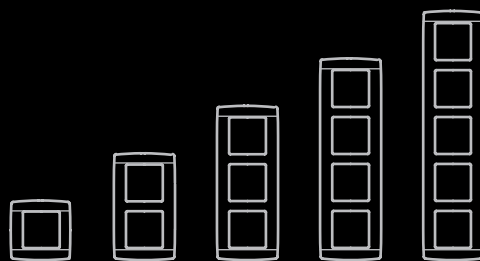

VSE NA ENEM MESTU IN ŠE VEČ
ALL IN ONE PLACE AND MORE

LOGIČNA MONTAŽA

LOGICAL INSTALLATION

LOGIQ je rešitev za sistem standardnih okroglih doz. Z njim lahko načrtujete tako enostavne kot tudi zahtevnejše inštalacije, novogradnje in adaptacije. Sistem odlikujejo brezvijačni kontakti, ki vam prihranijo čas pri vgradnji elementov.

LOGIQ is a solution for the system of standardized round installations boxes. It can be used for simple as well as more demanding installations, new buildings and adaptations. The system is characterised by plug-in contacts which save time during installation of elements.

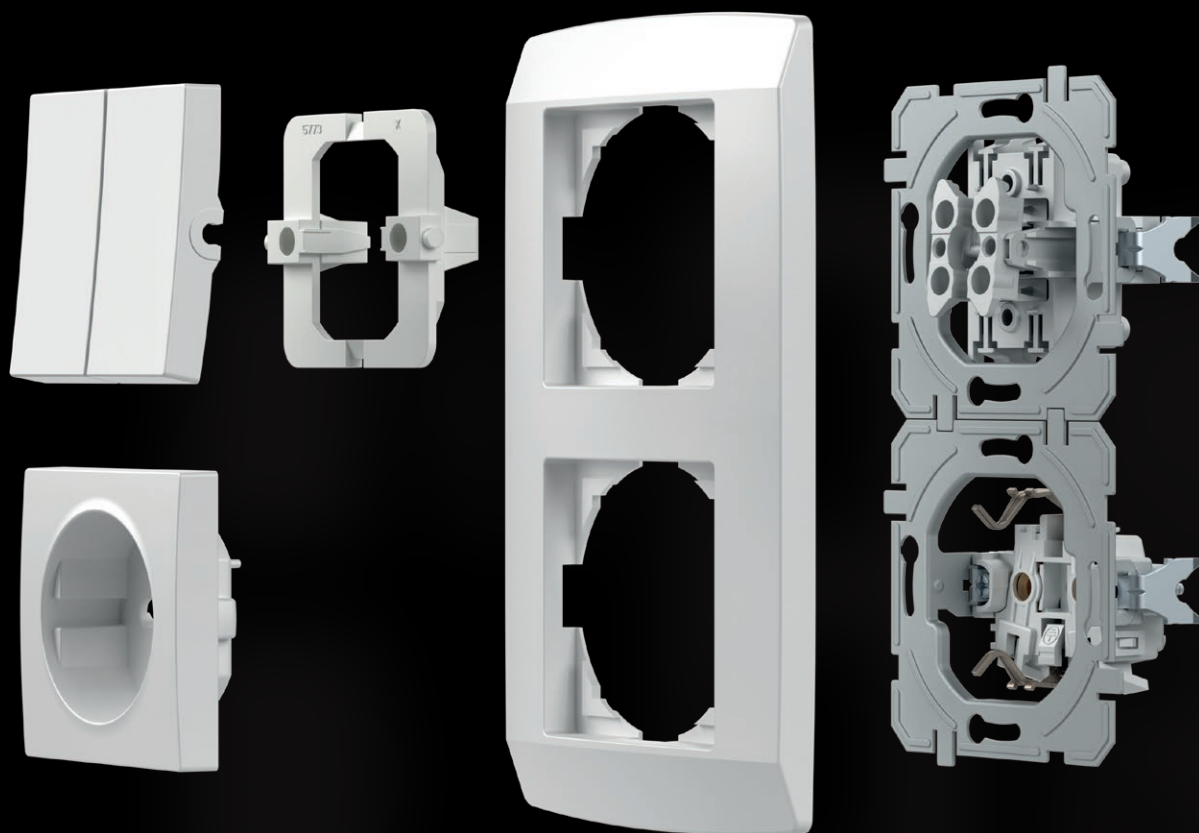

DOBRO JE VEDETI

GOOD TO KNOW



Vse vtičnice imajo vgrajeno varovalo pred dotikom elementov pod napetostjo.

All the sockets are equipped with a safety shutters assuring the protection to live contacts.

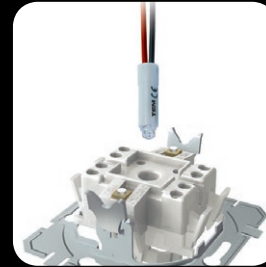

Dobro premišljena konstrukcija stikala omogoča enostavno osvetlitev tudi naknadno.

A well-planned switch construction makes easy illumination possible also subsequently.



Za zanesljivost preklopa skrbijo kontakti iz srebrne zlitine (AgNi).

Contacts made of silver alloy (Ag-Ni) guarantee safe switching.



Brezvijačni kontakti omogočajo hitro in zanesljivo priključitev vodnikov. Na isti kontakt lahko pritrdite dva vodnika različnih premerov.

Plug-in contacts enable quick and reliable attachment of wires. Two wires of different diameters can be attached to the same contact.



Krepeljci omogočajo globljo pritrditev (tudi preko keramičnih ploščic ipd.).

Fixing claws enable deeper fixing (also through ceramic tiles, etc.)

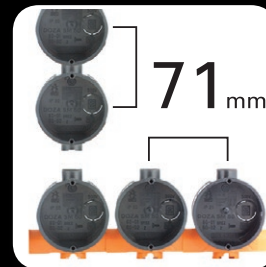

Sestavljive doze vam bodo olajšale delo. Prave razdalje so vam zagotovljene.

Easy-fitting installation boxes will make your work easier. Proper lengths are guaranteed.

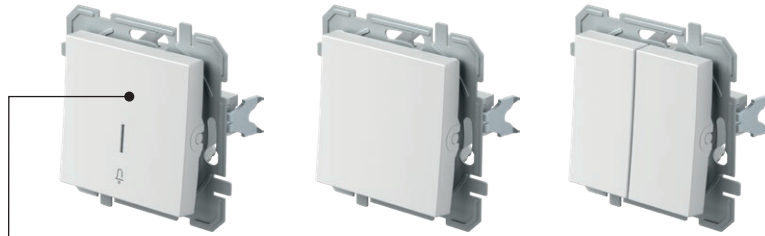





SQ11

PW

IN

01

XO

tip type	naziv description	tehnični opis technical data	barva colour	opcijski opis 1 optional data 1	opcijski opis 2 optional data 2	opcijski opis 3 optional data 3
SQ10	STIKALO ENOPOLNO SWITCH 1WAY	10AX 250V~	□ PW bela - sijaj polar white	 NT nevtiral neutral	 01	XO brez okvirja without cover plate
SQ11	TIPKALO ENOPOLNO PUSH BUTTON 1WAY	10A 250V~	■ TI titan titanium	 IN indikator indicator	 02	
SQ22	STIKALO DVOPOLNO SWITCH 2POLE	16AX 250V~	■ AT antracit anthracite		 03	
:	:	:	:	:	:	:

STIKALO ENOPOLNO 10AX 250V~

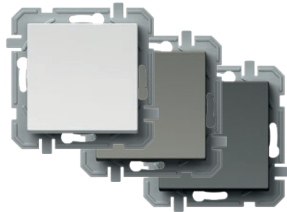

- SQ10PWXO
- SQ10TIXO
- SQ10ATXO

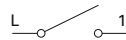

- 10AX 250V~, tip SQ10
- ustreza EN 60669-1
- brezvijačna pritrditev vodnikov 1.5-2.5mm²
- SWITCH 1WAY 10AX 250V~
- 10AX 250V~, type SQ10
- in accordance with EN 60669-1
- plug-in contacts 1.5-2.5mm²



STIKALO ENOPOLNO 10AX 250V~ __ IN



- SQ10PWINXO
- SQ10TIINXO
- SQ10ATINXO



- IN indikator, brez tlivke
- 10AX 250V~, tip SQ10
- ustreza EN 60669-1
- brezvijačna pritrditev vodnikov 1.5-2.5mm²
- SWITCH 1WAY 10AX 250V~ __ IN
- IN indicator, without neon lamp
- 10AX 250V~, type SQ10
- in accordance with EN 60669-1
- plug-in contacts 1.5-2.5mm²





- SQ11PWXO
- SQ11TIXO
- SQ11ATXO

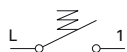

TIPKALO ENOPOLNO 10A 250V~

- 10A 250V~, tip SQ11
- ustreza EN 60669-1
- brezvijačna pritrditev vodnikov 1.5-2.5mm²

PUSH BUTTON 1WAY 10A 250V~

- 10A 250V~, type SQ11
- in accordance with EN 60669-1
- plug-in contacts 1.5-2.5mm²



- SQ11PWIN01XO
- SQ11TIIN01XO
- SQ11ATIN01XO

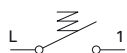

TIPKALO ENOPOLNO 10A 250V~ __ IN 01

- IN 01 indikator zvonec, brez tlivke
- 10A 250V~, tip SQ11
- ustreza EN 60669-1
- brezvijačna pritrditev vodnikov 1.5-2.5mm²

PUSH BUTTON 1WAY 10A 250V~ __ IN 01

- IN 01 indicator bell, without neon lamp
- 10A 250V~, type SQ11
- in accordance with EN 60669-1
- plug-in contacts 1.5-2.5mm²



- SQ11PWIN02XO
- SQ11TIIN02XO
- SQ11ATIN02XO

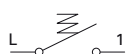

TIPKALO ENOPOLNO 10A 250V~ __ IN 02

- IN 02 indikator luč, brez tlivke
- 10A 250V~, tip SQ11
- ustreza EN 60669-1
- brezvijačna pritrditev vodnikov 1.5-2.5mm²

PUSH BUTTON 1WAY 10A 250V~ __ IN 02

- IN 02 indicator light, without neon lamp
- 10A 250V~, type SQ11
- in accordance with EN 60669-1
- plug-in contacts 1.5-2.5mm²

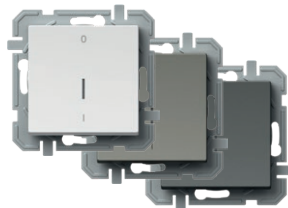

- SQ22PWIN03XO
- SQ22TIIN03XO
- SQ22ATIN03XO

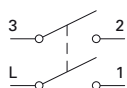

STIKALO DVOPOLNO 16AX 250V~ __ IN 03

- IN 03 nevtral 0-1, brez tlivke
- 16AX 250V~, tip SQ22
- ustreza EN 60669-1
- vijajna pritrditev vodnikov 1.5-2.5mm²

SWITCH 2POLE 16AX 250V~ __ IN 03

- IN 03 neutral 0-1, without neon lamp
- 16AX 250V~, type SQ22
- in accordance with EN 60669-1
- screw contacts 1.5-2.5mm²

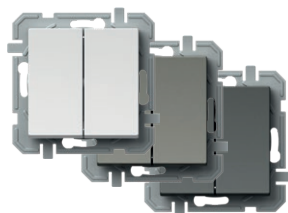

- SQ50PWXO
- SQ50TIXO
- SQ50ATXO

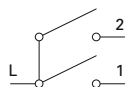

STIKALO SERIJSKO 10AX 250V~

- 10AX 250V~, tip SQ50
- ustreza EN 60669-1
- brezvijačna pritrditev vodnikov 1.5-2.5mm²

SWITCH 2GANG-1WAY 10AX 250V~

- 10AX 250V~, type SQ50
- in accordance with EN 60669-1
- plug-in contacts 1.5-2.5mm²





- SQ51PWXO
- SQ51TIXO
- SQ51ATXO

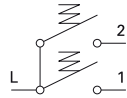

TIPKALO SERIJSKO 10A 250V~

- 10A 250V~, tip SQ51
- ustreza EN 60669-1
- brezvijačna pritrditev vodnikov 1.5-2.5mm²

PUSH BUTTON 2GANG-1WAY 10A 250V~

- 10A 250V~, type SQ51
- in accordance with EN 60669-1
- plug-in contacts 1.5-2.5mm²



- SQ52PWNT09XO
- SQ52TINT09XO
- SQ52ATNT09XO

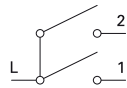

STIKALO ŽALUZIJSKO 10AX 250V~ __ NT 09

- NT 09 nevtral gor-dol
- 10AX 250V~, tip SQ52
- ustreza EN 60669-1
- brezvijačna pritrditev vodnikov 1.5-2.5mm²
- z mehansko blokado hkratnega vklopa

SWITCH SHUTTERS 10AX 250V~ __ NT 09

- NT 09 neutral up-down
- 10AX 250V~, type SQ52
- in accordance with EN 60669-1
- plug-in contacts 1.5-2.5mm²
- with mechanical interblock



- SQ53PWNT09XO
- SQ53TINT09XO
- SQ53ATNT09XO

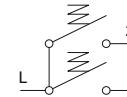

TIPKALO ŽALUZIJSKO 10A 250V~ __ NT 09

- NT 09 nevtral gor-dol
- 10A 250V~, tip SQ53
- ustreza EN 60669-1
- brezvijačna pritrditev vodnikov 1.5-2.5mm²
- z mehansko blokado hkratnega vklopa

PUSH BUTTON SHUTTERS 10A 250V~ __ NT 09

- NT 09 neutral up-down
- 10A 250V~, type SQ53
- in accordance with EN 60669-1
- plug-in contacts 1.5-2.5mm²
- with mechanical interblock

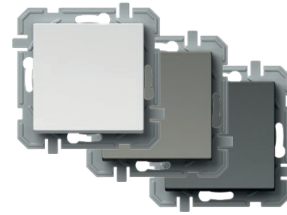

- SQ60PWXO
- SQ60TIXO
- SQ60ATXO

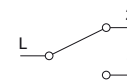

STIKALO MENJALNO 10AX 250V~

- 10AX 250V~, tip SQ60
- ustreza EN 60669-1
- brezvijačna pritrditev vodnikov 1.5-2.5mm²

SWITCH 2WAY 10AX 250V~

- 10AX 250V~, type SQ60
- in accordance with EN 60669-1
- plug-in contacts 1.5-2.5mm²



- SQ63PWXO
- SQ63TIXO
- SQ63ATXO

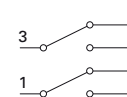

STIKALO DVOJNO MENJALNO 10AX 250V~

- 10AX 250V~, tip SQ63
- ustreza EN 60669-1
- brezvijačna pritrditev vodnikov 1.5-2.5mm²

SWITCH DOUBLE 2WAY 10AX 250V~

- 10AX 250V~, type SQ63
- in accordance with EN 60669-1
- plug-in contacts 1.5-2.5mm²



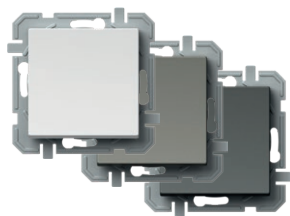

- SQ70PWXO
- SQ70TIXO
- SQ70ATXO



STIKALO KRIŽNO 10AX 250V~

- 10AX 250V~, tip SQ70
- ustreza EN 60669-1
- brezvijačna pritrditev vodnikov 1.5-2.5mm²

SWITCH INTERMEDIATE 10AX 250V~

- 10AX 250V~, type SQ70
- in accordance with EN 60669-1
- plug-in contacts 1.5-2.5mm²



SQ10
SQ11

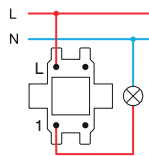

SQ22

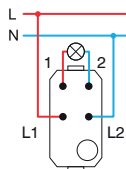

SQ50
SQ51

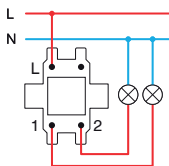

SQ52
SQ53

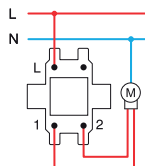

SQ60+SQ60

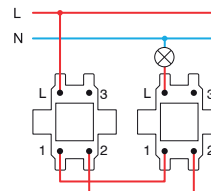

SQ63+SQ63

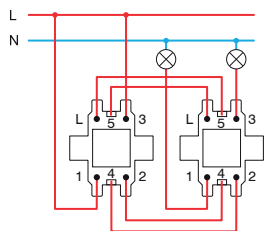

SQ60+SQ70+SQ60

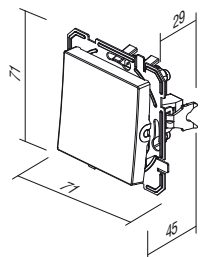
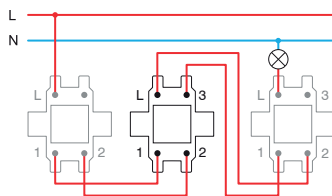

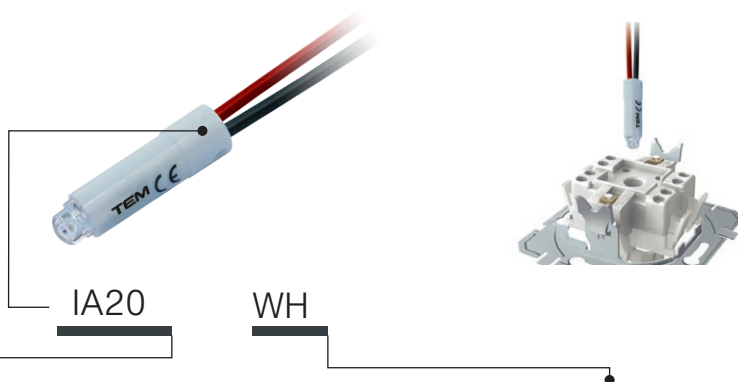

tip type	naziv description	tehnični opis technical data	barva colour
IA10	TLIVKA NEON LAMP	230V~ 0,34W	<input type="checkbox"/> WH bela white
IA20	LED SIGNALIZACIJA LED SIGNALLING UNIT	230V~ 0,40W	<input checked="" type="checkbox"/> BL modra blue
IA21	LED SIGNALIZACIJA LED SIGNALLING UNIT	24V AC/DC 0,20W	<input checked="" type="checkbox"/> RD rdeča red
.	.	.	<input checked="" type="checkbox"/> GR zelena green
.	.	.	<input checked="" type="checkbox"/> OR oranžna orange

TLIVKA 230V~ 0,34W

 IA10OR

- za indikacijo, osvetlitev ali stalno osvetlitev stikala
- v kombinaciji s tipko z indikatorjem

NEON LAMP 230V~ 0,34W

- for indication, illumination or constant illumination of switch
- in combination with button with indicator

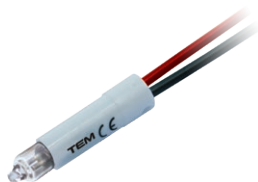

LED SIGNALIZACIJA 230V AC/DC 0,40W

IA20WH
 IA20GR
 IA20RD
 IA20BL

- za indikacijo, signalizacijo ali stalno signalizacijo stikala
- v kombinaciji s tipko z indikatorjem

LED SIGNALLING UNIT 230V AC/DC 0,40W

- for indication, signalling or permanent signalling
- in combination with a button featuring an indicator

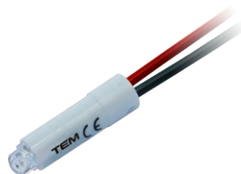

LED SIGNALIZACIJA 24V AC/DC 0,20W

IA21WH
 IA21RD

- za indikacijo, signalizacijo ali stalno signalizacijo stikala
- v kombinaciji s tipko z indikatorjem

LED SIGNALLING UNIT 24V AC/DC 0,20W

- for indication, signalling or permanent signalling
- in combination with a button featuring an indicator

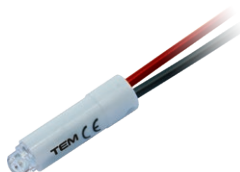

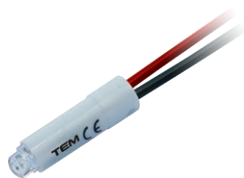

- IA22WH
- IA22RD

LED SIGNALIZACIJA 12V AC/DC 0,10W

- za indikacijo, signalizacijo
- ali stalno signalizacijo stikala
- v kombinaciji s tipko z indikatorjem

LED SIGNALLING UNIT 12V AC/DC 0,10W

- *for indication, signalling*
- *or permanent signalling*
- *in combination with a button featuring an indicator*

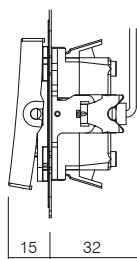

* Indikacija /
Indication

Signalizacija /
Signalization

* Stalna signalizacija /
Permanent signalling

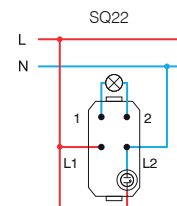
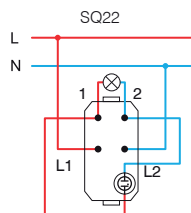
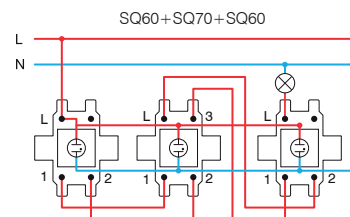
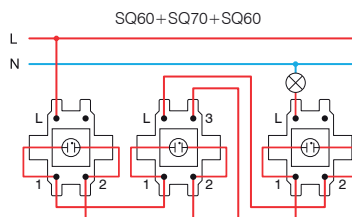
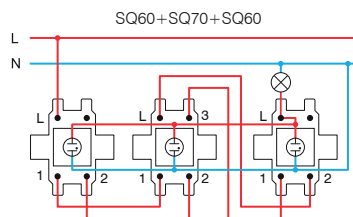
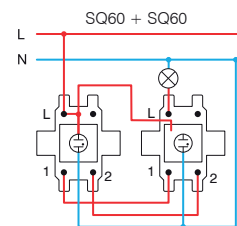
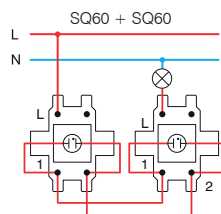
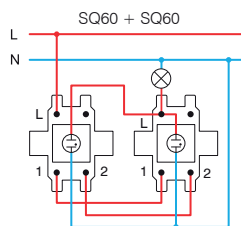
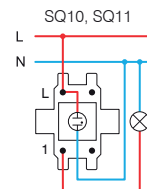
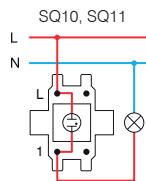
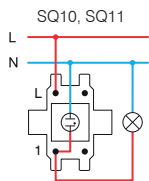

* vezave primerne za varčne (CFL, LED) sijalke /
wiring scheme for energy saving lamps (CFL, LED)

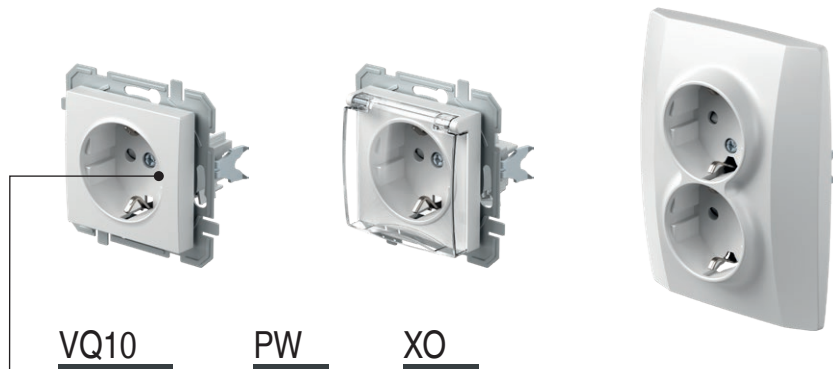

tip <i>type</i>	naziv <i>description</i>	tehnični opis <i>technical data</i>	opcijski opis 1 <i>optional data 1</i>
VQ10	VTIČNICA SCHUKO SOCKET SCHUKO	2P+E 16A 250V~	XO brez okvirja without cover plate
VQ11	VTIČNICA SCHUKO+POKROV SOCKET SCHUKO+COVER	2P+E 16A 250V~	
VQ12	VTIČNICA SCHUKO SOCKET SCHUKO	2P+E 16A 250V~ BV	
:	:	:	
:	:	:	

barva
colour

<input type="checkbox"/> PW	bela - sijaj <i>polar white</i>	<input type="checkbox"/> PT	bela+prozorna <i>white+transparent</i>	<input type="checkbox"/> PP	bela+bela <i>white+white</i>
<input type="checkbox"/> TI	titan <i>titanium</i>	<input type="checkbox"/> TT	titan+prozorna <i>titanium+transparent</i>	<input type="checkbox"/> TI	titan+titan <i>titanium+titanium</i>
<input type="checkbox"/> AT	antracit <i>anthracite</i>	<input type="checkbox"/> AT	antracit+prozorna <i>anthracite+transparent</i>	<input type="checkbox"/> AA	antracit+antracit <i>anthracite+anthracite</i>
<input type="checkbox"/> RD	rdeča <i>red</i>	<input type="checkbox"/> RT	rdeča+prozorna <i>red+transparent</i>	<input type="checkbox"/> RR	rdeča+rdeča <i>red+red</i>
<input type="checkbox"/> GR	zelena <i>green</i>	<input type="checkbox"/> GT	zelena+prozorna <i>green+transparent</i>	<input type="checkbox"/> GG	zelena+zelena <i>green+green</i>
<input type="checkbox"/> OR	oranžna <i>orange</i>	<input type="checkbox"/> OT	oranžna+prozorna <i>orange+transparent</i>	<input type="checkbox"/> OO	oranžna+oranžna <i>orange+orange</i>



schuko - ustreza EN 60884-1, CEE7 (list III)

schuko - in accordance with EN 60884-1, CEE7 (standard sheet III)

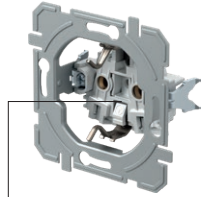

vijačna pritrditvev vodnikov
screw contacts

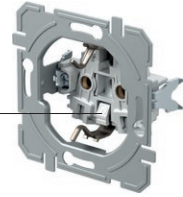

BV brezvijačna pritrditvev vodnikov
BV plug-in contacts

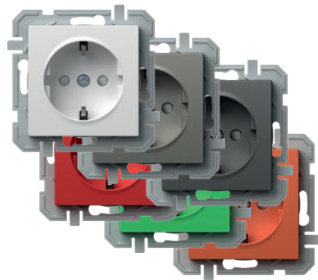

- VQ10PWXO
- VQ10TIXO
- VQ10ATXO
- VQ10RDXO
- VQ10GRXO
- VQ10ORXO

VTIČNICA SCHUKO 2P+E 16A 250V~ __ XO

- vijačna pritrditvev vodnikov 1.5-2.5mm²
- XO brez okvirja
- 2P+E schuko
- 16A 250V~, tip VQ10
- vgrajena zaščita pred dotikom kontaktov

SOCKET SCHUKO 2P+E 16A 250V~ __ XO

- screw contacts 1.5-2.5mm²
- XO without surround
- 2P+E schuko
- 16A 250V~, type VQ10
- shuttered live contacts

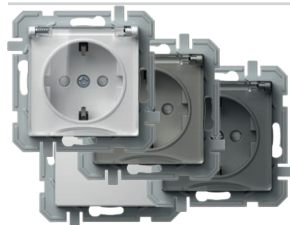

- VQ11PTXO
- VQ11TTXO
- VQ11ATXO
- VQ11PPXO

VTIČNICA SCHUKO+POKROV 2P+E 16A 250V~ __ XO

- vijačna pritrditvev vodnikov 1.5-2.5mm²
- XO brez okvirja
- 2P+E schuko+pokrov
- 16A 250V~, tip VQ11
- vgrajena zaščita pred dotikom kontaktov

SOCKET SCHUKO+COVER 2P+E 16A 250V~ __ XO

- screw contacts 1.5-2.5mm²
- XO without surround
- 2P+E schuko+cover
- 16A 250V~, type VQ11
- shuttered live contacts

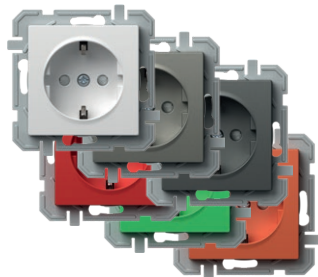

- VQ12PWXO
- VQ12TIXO
- VQ12ATXO
- VQ12RDXO
- VQ12GRXO
- VQ12ORXO

VTIČNICA SCHUKO 2P+E 16A 250V~ BV __ XO

- BV brezvijačna pritrditvev vodnikov 1.5-2.5mm²
- XO brez okvirja
- 2P+E schuko
- 16A 250V~, tip VQ12
- vgrajena zaščita pred dotikom kontaktov

SOCKET SCHUKO 2P+E 16A 250V~ BV __ XO

- BV plug-in contacts 1.5-2.5mm²
- XO without surround
- 2P+E schuko
- 16A 250V~, type VQ12
- shuttered live contacts



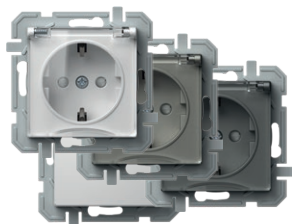

- VQ13PTXO
- VQ13TTXO
- VQ13ATXO
- VQ13PPXO

VTIČNICA SCHUKO+POKROV 2P+E 16A 250V~ BV __ XO

- BV brezvijačna pritrditev vodnikov 1.5-2.5mm²
- XO brez okvirja
- 2P+E schuko+pokrov
- 16A 250V~, tip VQ13
- vgrajena zaščita pred dotikom kontaktov



SOCKET SCHUKO+COVER 2P+E 16A 250V~ BV __ XO

- BV plug-in contacts 1.5-2.5mm²
- XO without surround
- 2P+E schuko+cover
- 16A 250V~, type VQ13
- shuttered live contacts



- VQ16PW
- VQ16TI
- VQ16AT

VTIČNICA SCHUKO DVOJNA 2P+E 16A 250V~

- 2P+E schuko dvojna
- 16A 250V~, tip VQ16
- ustreza IEC 60884-1, CEE7
- vijačna pritrditev vodnikov 1.5-2.5 mm²
- vgrajena zaščita pred dotikom kontaktov

SOCKET SCHUKO DOUBLE 2P+E 16A 250V~

- 2P+E schuko double
- 16A 250V~, type VQ16
- in accordance with IEC 60884-1, CEE7
- screw contacts 1.5-2.5 mm²
- shuttered live contacts

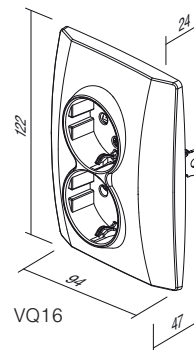
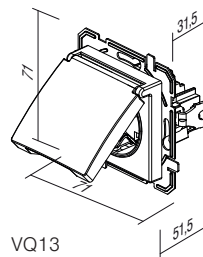
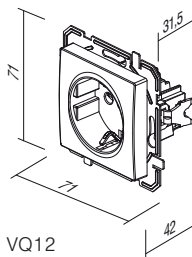
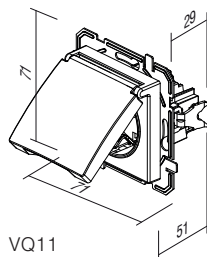
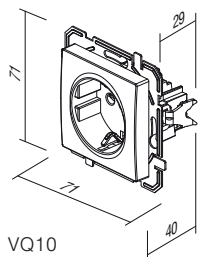



KQ37

PW

XO

tip type	naziv description	tehnični opis technical data	barva colour	opsijski opis 1 optional data 1
KQ11	VTIČNICA TV-R KONČNA SOCKET TV-R END-LINE	1dB	<input type="checkbox"/> PW bela - sijaj polar white	XO brez okvirja without cover plate
KQ12	VTIČNICA TV-R PREHODNA SOCKET TV-R THROUGHPASS	10dB	<input type="checkbox"/> TI titan titanium	
KQ16	VTIČNICA SAT-TV-R KONČNA SOCKET SAT-TV-R END-LINE	3dB	<input type="checkbox"/> AT antracit anthracite	
⋮	⋮	⋮		

VTIČNICA TV OSNOVNA 0dB



- KQ10PWXO
- KQ10TIXO
- KQ10ATXO

- TV osnovna
- dušenje 0dB
- konektor zadaj – F standard

SOCKET TV BASIC 0dB

- TV basic
- reduction 0dB
- back connector – F standard



VTIČNICA TV-R KONČNA 1dB



- KQ11PWXO
- KQ11TIXO
- KQ11ATXO

- TV-R končna
- frekvenčni pas 5÷862 MHz
- dušenje: R-1,5dB, TV-1dB
- ustreza EN 50083-1
- vijajčna priključitev

SOCKET TV-R END-LINE 1dB

- TV-R end-line
- frequency range 5÷862 MHz
- reduction: R-1.5dB, TV-1dB
- in accordance with EN 50083-1
- screw contact





- KQ12PWXO
- KQ12TIXO
- KQ12ATXO

VTIČNICA TV-R PREHODNA 10dB

- TV-R prehodna
- frekvenčni pas 5÷862 MHz
- dušenje: R-10dB, TV-10dB, prehod-2dB
- ustreza EN 50083-1
- vijajčna priključitev

SOCKET TV-R TROUGH-PASS 10dB

- TV-R troughpass
- frequency range 5÷862 MHz
- reduction: R-10dB, TV-10dB, trough-2dB
- in accordance with EN 50083-1
- screw contacts



- KQ16PWXO
- KQ16TIXO
- KQ16ATXO

VTIČNICA SAT-TV-R KONČNA 3dB

- SAT-TV-R končna
- frekvenčni pas 5÷2400 MHz
- dušenje: R-1dB, TV-1.5dB, SAT-3dB
- ustreza EN 50083-1
- vijajčna priključitev

SOCKET SAT-TV-R END-LINE 3dB

- SAT-TV-R end-line
- frequency range 5÷2400 MHz
- reduction: R-1dB, TV-1.5dB, SAT-3dB
- in accordance with EN 50083-1
- screw contacts

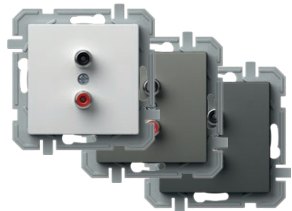

- KQ22PWXO
- KQ22TIXO
- KQ22ATXO

VTIČNICA AVDIO 2xRCA

- avdio 2xRCA
- pritrditev vodnikov s spajkanjem

SOCKET AUDIO 2xRCA

- audio 2xRCA
- soldering connection of cable



- KQ23PWXO
- KQ23TIXO
- KQ23ATXO

VTIČNICA AVDIO ZVOČNIŠKA

- avdio 2x Ø4mm
- za priklop zvočniškega vodnika, vtiča Ø4mm ali viličastega kabel čevlja
- pritrditev vodnikov zadaj s spajkanjem

SOCKET AUDIO LOUDSPEAKERS

- audio 2x Ø4mm
- to accommodate speaker wire, banana plug Ø4mm or spades
- soldering connection of cable at the back side

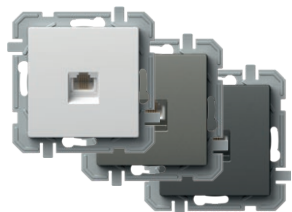

- KQ36PWXO
- KQ36TIXO
- KQ36ATXO

VTIČNICA TEL KS RJ11 6/4

- KS keystone pritrditveni standard
- RJ11 6/4
- ustreza IEC 60603-7

SOCKET TEL KS RJ11 6/4

- KS keystone fixing standard
- RJ11 6/4
- in accordance with IEC 60603-7



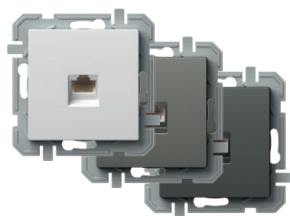

- KQ37PWXO
- KQ37TIXO
- KQ37ATXO

VTIČNICA CAT5e KS RJ45 8/8

- KS keystone pritrditveni standard
- CAT5e, RJ45 8/8
- ustreza IEC 60603-7

SOCKET CAT5e KS RJ45 8/8

- KS keystone fixing standard
- CAT5e, RJ45 8/8
- in accordance with IEC 60603-7

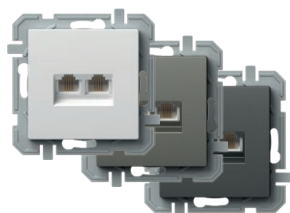

- KQ38PWXO
- KQ38TIXO
- KQ38ATXO

VTIČNICA TEL KS DVOJNA 2x RJ11 6/4

- KS keystone pritrditveni standard
- 2x RJ11, 6/4
- ustreza IEC 60603-7

SOCKET TEL KS DOUBLE 2x RJ11 6/4

- KS keystone fixing standard
- 2x RJ11, 6/4
- in accordance with IEC 60603-7

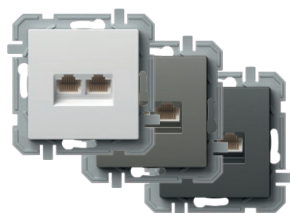

- KQ39PWXO
- KQ39TIXO
- KQ39ATXO

VTIČNICA CAT5e KS DVOJNA 2x RJ45 8/8

- KS keystone pritrditveni standard
- 2x CAT5e, RJ45 8/8
- ustreza IEC 60603-7

SOCKET CAT5e KS DOUBLE 2x RJ45 8/8

- KS keystone fixing standard
- 2x CAT5e, RJ45 8/8
- in accordance with IEC 60603-7

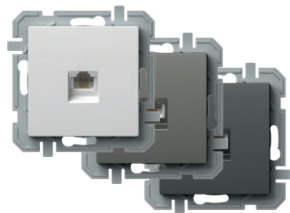

- KQ35PWXO
- KQ35TIXO
- KQ35ATXO

VTIČNICA TEL LT RJ11 6/4

- TEL LT vijak
- vijačna pritrditev vodnikov
- RJ11 6/4
- ustreza IEC 60603-7

SOCKET TEL LT RJ11 6/4

- TEL LT screw
- screw contacts
- RJ11 6/4
- in accordance with IEC 60603-7

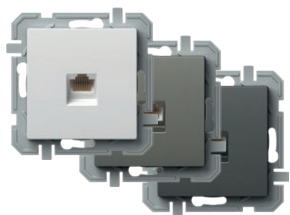

- KQ40PWXO
- KQ40TIXO
- KQ40ATXO

VTIČNICA CAT6s KS RJ45 8/8 SLIM

- KS keystone pritrditveni standard
- CAT6s, RJ45 8/8
- ustreza IEC 60603-7

SOCKET CAT6s KS RJ45 8/8 SLIM

- KS keystone fixing standard
- CAT6s, RJ45 8/8
- in accordance with IEC 60603-7



VTIČNICA CAT6s KS DVOJNA 2x RJ45 8/8 SLIM

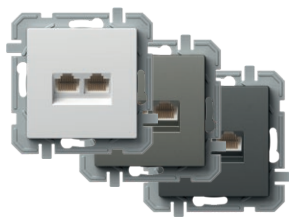

- KQ41PWXO
- KQ41TIXO
- KQ41ATXO

- KS keystone pritrditveni standard
- 2xCAT6, RJ45 8/8
- ustreza IEC 60603-7

SOCKET CAT6s KS DOUBLE 2x RJ45 8/8 SLIM

- KS keystone fixing standard
- 2x CAT6s, RJ45 8/8
- in accordance with IEC 60603-7

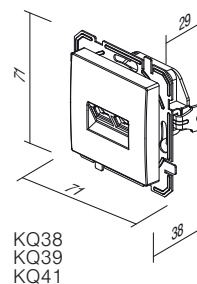
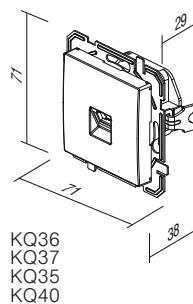
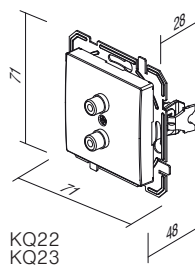
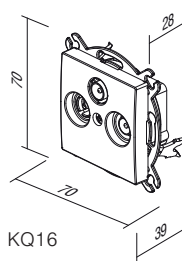
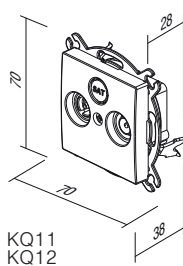
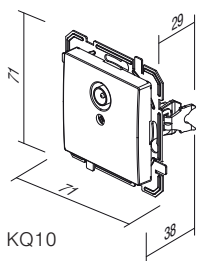

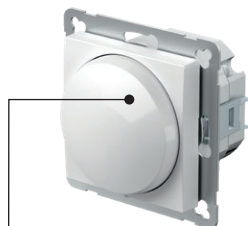

EQ15

PW

XO

tip type	naziv description	tehnični opis technical data	barva colour	opsijski opis 1 optional data 1
EQ15	ZATEMNILNIK ROTACIJSKI MEN DIMMER ROTATIVE 2WAY	RL 400W	<input type="checkbox"/> PW bela - sijaj polar white	XO brez okvirja without cover plate
EQ16	ZATEMNILNIK ROTACIJSKI MEN DIMMER ROTATIVE 2WAY	RLC 400W	<input type="checkbox"/> TI titan titanium	
EQ19	ZATEMNILNIK ROTACIJSKI MEN DIMMER ROTATIVE 2WAY	LED 100W	<input type="checkbox"/> AT antracit anthracite	
⋮	⋮	⋮		

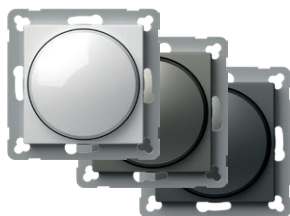

- EQ15PWXO
- EQ15TIXO
- EQ15ATXO

ZATEMNILNIK ROTACIJSKI MEN RL 400W

- rotacijski z menjalnim stikala
- breme RL, 40W - 400W
- možna vezava z menjalnim stikalom
- vezava več zatemnilnikov ni dovoljena
- ustreza EN 60669-1 in EN 60669-2-1
- brezvijačna pritrditev vodnikov 1.5mm²
- napajanje 230V~ 50Hz
- zamenljiva varovalka vključena

DIMMER ROTATIVE 2WAY RL 400W

- rotation control with 2-way switch
- load RL, 40W - 400W
- 2-way switch combination is possible
- more dimmers combination is not allowed
- in accordance with EN 60669-1 and EN 60669-2-1
- plug-in contacts 1.5mm²
- supply 230V~ 50Hz
- replaceable fuse included



ZATEMNILNIK ROTACIJSKI MEN RLC 400W

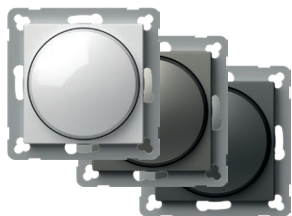

- EQ16PWXO
- EQ16TIXO
- EQ16ATXO

- rotacijski z menjalnim stikalom
- breme RLC, 20W - 400W
- možna vezava z menjalnim stikalom
- vezava več zatemnilnikov ni dovoljena
- ustreza EN 60669-1 in EN 60669-2-1
- brezvijačna pritrditev vodnikov 1.5mm²
- napajanje 230V~ 50Hz
- elektronska varovalka

*DIMMER ROTATIVE 2WAY RLC 400W*

- rotation control with 2-way switch
- load RLC, 20W - 400W
- 2-way switch combination is possible
- more dimmers combination is not allowed
- in accordance with EN 60669-1 and EN 60669-2-1
- plug-in contacts 1.5mm²
- supply 230V~ 50Hz
- electronic fuse

ZATEMNILNIK ROTACIJSKI MEN LED 100W

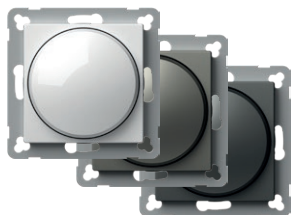

- EQ19PWXO
- EQ19TIXO
- EQ19ATXO

- rotacijski z menjalnim stikalom
- breme: LED, 0-100W (max. 10 LED sijalk) GLS, 10-250W
- možna vezava z menjalnim stikalom
- vezava več zatemnilnikov ni dovoljena
- ustreza EN 60669-1 in EN 60669-2-1
- brezvijačna pritrditev vodnikov 1,5 mm²
- napajanje 230V~ 50 Hz
- zamenljiva varovalka vključena

*DIMMER ROTATIVE 2WAY LED 100W*

- rotation control with 2-way switch
- load: LED, 0-100W (max. 10 LEDs) GLS, 10-250W
- 2-way switch combination is possible
- more dimmers combination is not allowed
- in accordance with EN 60669-1 and EN 60669-2-1
- plug-in contacts 1.5mm²
- supply 230V~ 50Hz
- replaceable fuse included

EQ15, EQ16, EQ19

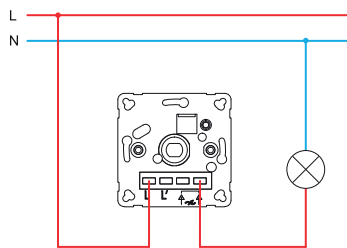

EQ15, EQ16, EQ19

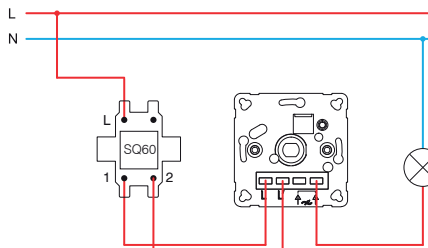

EQ15, EQ16, EQ19

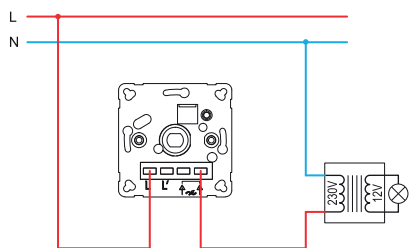

EQ15, EQ16, EQ19

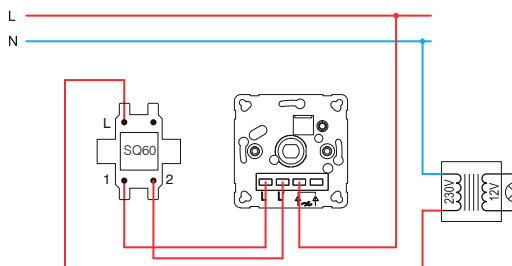

EQ16, EQ19

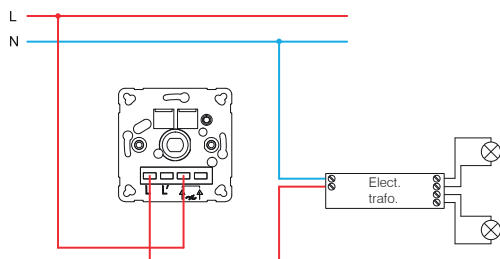

EQ16, EQ19

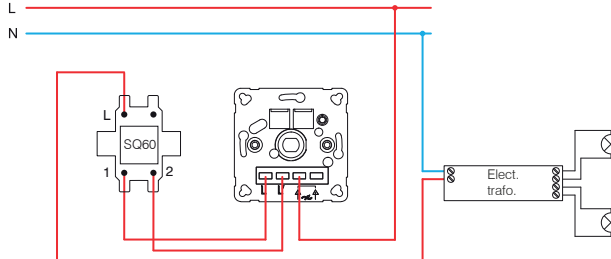

EQ15 (40÷400W)

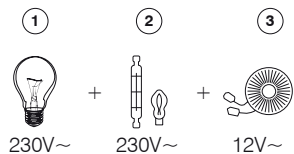

- 1 - žarnica z žarilno nitko / incandescent lamp
- 2 - halogenska žarnica / halogen lamp

EQ16 (20÷400W)

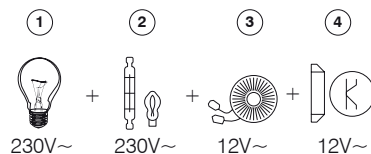

- 3 - klasični transformator / classical transformer
- 4 - zatemnilni el. transformator / dimmable electronic transformer

EQ19 (GLS 10÷250W ; LED 0÷100W)

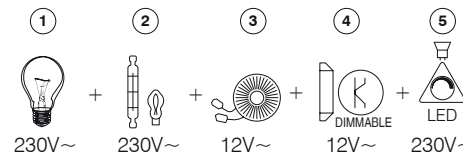

- 5 - zatemnilna LED sijalka / dimmable LED lamp

IR STIKALO 5A 230V~

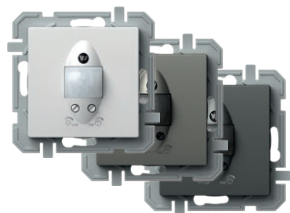

- EQ32PWXO
- EQ32TIXO
- EQ32ATXO

- IR infrardeče stikalo
- napajanje: 230V~ ±10 % 50Hz
- Rele :5A/250V~ (zero crossing)
- stopnja varnosti: IP40
- presek žic pri stičniku: 0,75 - 2,5 mm²
- kot zaznavanja: do 110° pri 20°C
- območje zaznavanja: približno 8 m pri 20°C
- nastavljenost časovnega trajanja: od približno 5 s do 12 min
- nastavljenost osvetlitve: od približno 5 do 200 LUX
- temperatura delovanja: od 0°C do +40°C
- ni primeren za vgradnjo v doze, globine 45 mm
- samo za notranjo uporabo

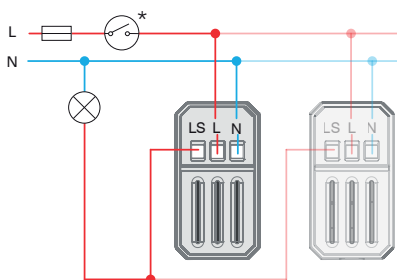

IR SWITCH 5A 230V~

- IR infrared switch
- supply voltage: 230V~ ±10 % 50Hz
- Relay :5A/250V~ (zero crossing)
- protection rating: IP40
- cross-section of wires at the contact terminal: 0.75 - 2.5 mm²
- detection angle: up to 110° at 20°C
- detection area: approx. 8 m at 20°C
- adjustability of duration: from approx. 5 s to 12 min
- adjustability of brightness: from approx. 5 to 200 LUX
- operating temperature: from 0°C to +40°C
- not suitable for installation in 45 mm deep boxes
- only for indoor usage

TERMOSTAT OGREVANJE 10A 230V~

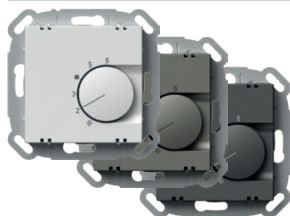

- EQ35PWXO
- EQ35TIXO
- EQ35ATXO

- način delovanja: ogrevanje
- napajanje: 230 V~, 50 Hz
- izhod: 4 A (max. 10 A), 230 V~, 50 Hz
- izhodni priključek: NC (max. 10 aktuatorjev)
- območje regulacije: +5 °C do +30 °C
- histereza: 0,5 K
- zaščita: IP30
- vrsta tipala: bimetal
- vrsta električnega priključka: vzmetni kontakti
- vrsta vodnikov: 0,75 – 1,5mm² (mehko-žilni) ali 1,0 – 2,5 mm² (trdo-žilni)

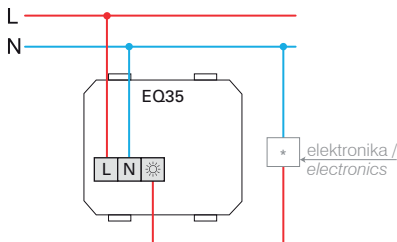

THERMOSTAT HEATING 10A 230V~

- operation mode: heating
- power supply: 230 V~, 50 Hz
- output: 4 A (max. 10 A), 230 V~, 50 Hz
- switching contact: NC (max. 10 actuators)
- regulation range: +5 °C to +30 °C
- hysteresis: 0,5 K
- protection: IP30
- sensor type: bimetal
- type of electrical connection: spring-loaded contacts
- type of conductors: 0,75 – 1,5mm² (flexible-stranded core) or 1,0 – 2,5 mm² (solid core)

TERMOSTAT OGREVANJE / HLAJENJE 5A 230V~

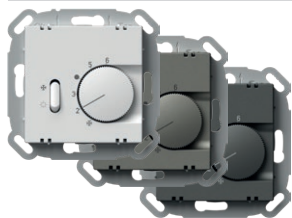

- EQ36PWXO
- EQ36TIXO
- EQ36ATXO

- način delovanja: ogrevanje / hlajenje
- napajanje: 230 V~, 50 Hz
- izhod: 2 A (max. 5 A), 230 V~, 50 Hz
- izhodni priključek: preklopno stikalo (max. 5 aktuatorjev)
- območje regulacije: +5 °C do +30 °C
- histereza: 0,5 K
- zaščita: IP30
- vrsta tipala: bimetal
- vrsta električnega priključka: vzmetni kontakti
- vrsta vodnikov: 0,75 – 1,5mm² (mehko-žilni) ali 1,0 – 2,5 mm² (trdo-žilni)

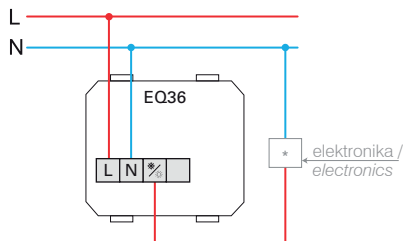

THERMOSTAT HEATING / COOLING 5A 230V~

- operation mode: heating / cooling
- power supply: 230 V~, 50 Hz
- output: 2 A (max. 5 A), 230 V~, 50 Hz
- switching contact: changeover switch (toggler, max. 5 actuators)
- regulation range: +5 °C to +30 °C
- hysteresis: 0,5 K
- protection: IP30
- sensor type: bimetal
- type of electrical connection: spring-loaded contacts
- type of conductors: 0,75 – 1,5mm² (flexible-stranded core) or 1,0 – 2,5 mm² (solid core)

TERMOSTAT TALNO OGREVANJE 16A 230V~

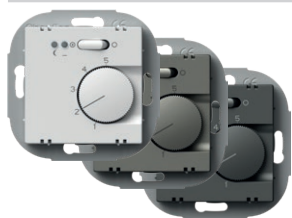

- EQ37PWXO
- EQ37TIXO
- EQ37ATXO

- način delovanja: talno ogrevanje
- napajanje: 230 V~, 50 Hz
- izhod: 2 A (max. 16 A), 230 V~, 50 Hz
- območje regulacije: +10 °C do +50 °C
- histereza: 1 K
- zaščita: IP30
- vrsta tipala: NTC v skladu z DIN EN 60730-2-1
- indikatorji: rdeča LED za ogrevanje in zelena LED za nočni zmanjšani način
- vrsta električnega priključka: vijalni kontakti
- vrsta vodnikov: 0,5 – 2,5 mm²

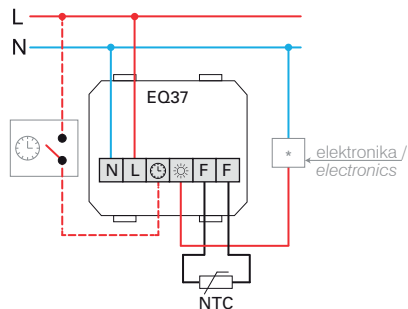

THERMOSTAT FLOOR HEATING 16A 230V~

- operation mode: floor heating
- power supply: 230 V~, 50 Hz
- output: 2 A (max. 16 A), 230 V~, 50 Hz
- regulation range: +10 °C to +50 °C
- hysteresis: 1 K
- protection: IP30
- sensor type: NTC in compliance with DIN EN 60730-2-1
- indicators: Red LED for heating and green LED for night decrease mode
- type of electrical connection: Screw contacts
- type of conductors: 0,5 – 2,5mm²

POLNILNIK USB 5V 3,0A



- EQ68PWXO
- EQ68TIXO
- EQ68ATXO

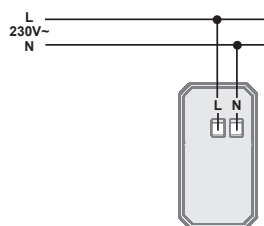

elektronika /

- za polnjenje elektronskih naprav prek standardnega USB priključka (kompatibilno tudi z Apple napravami)
- napajanje: 100-230 V[~] 50/60 Hz
- poraba med delovanjem: 300 mA pri 100 V[~]/150 mA pri 230 V[~]
- poraba v mirovanju: 30 mW pri 230 V[~]
- izhodna napetost: 5 VDC (±5 %) SELV
- nihanje izhodne napetosti: 150 mV
- nominalni izhodni tok: 3,0 A (±10 %)
- tip konektorja: USB A / USB C
- učinkovitost: maksimalno 77 %
- temperatura delovanja: 0 °C/+ 45 °C (notranja uporaba)
- IP zaščitni razred: IP20, samo za notranjo uporabo
- varnostni razred naprave II
- prenapetostna zaščita (EN 62109): razred III
- vijačna pritrditev vodnikov max. 2,5 mm²
- naprava z odmikom kontaktov min. 3 mm
- ustreza standardu EN 60950-1 in direktivam EMC in LVD

USB POWER SUPPLY UNIT 5V 3.0A

- for charging electronic devices via a standard USB port (also compatible with Apple devices)
- power supply: 100-230V[~] 50/60Hz
- power consumption: 300mA at 100V[~]/150mA at 230V[~]
- standby power consumption: 30mW at 230V[~]
- nominal output voltage: 5 VCD (± 5%) SELV
- output ripple voltage: 150mV
- nominal output current: 3.0 A (±10%)
- connector type: USB A / USB C
- efficiency: maximum of 77%
- operating temperature: 0°C/+45°C (indoor use)
- IP protection class: IP20, indoor use only
- class device II
- overvoltage category (EN 62109): Class III
- screw contacts: max. 2.5 mm²
- device with a contact gap of at least 3mm
- in accordance with the EN 60950-1 and LVD & EMC directives

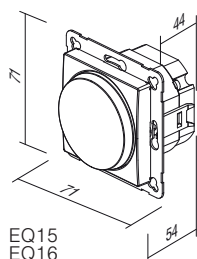

EQ15
EQ16
EQ19

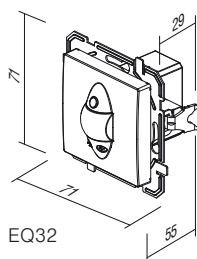

EQ32

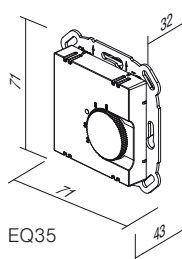

EQ35

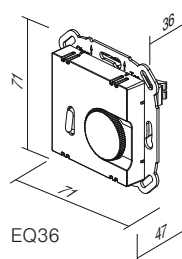

EQ36

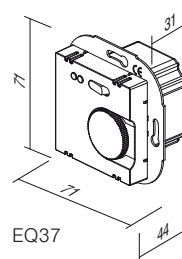

EQ37

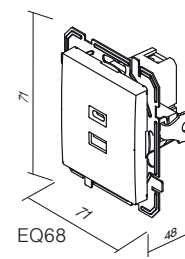

EQ68

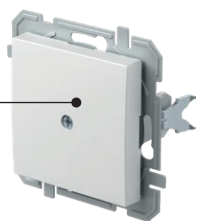

PQ10

PW

XO

tip type	naziv description	barva colour	opcijski opis 1 optional data 1
PQ10	POLNILO BLANK	<input type="checkbox"/> PW bela - sijaj polar white	XO brez okvirja without cover plate
PQ30	POKROV TAE/TDO COVER TAE/TDO	<input type="checkbox"/> TI titan titanium <input type="checkbox"/> AT antracit anthracite	

POLNILO



- PQ10PWXO
- PQ10TIXO
- PQ10ATXO

- za pokrivanje praznih odprtin
BLANK
- for filling up empty spaces



POKROV TAE/TDO

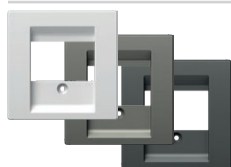

- PQ30PW
- PQ30TI
- PQ30AT

- TAE ali TDO pokrov z vijakom
COVER TAE/TDO
- TAE or TDO cover with screw

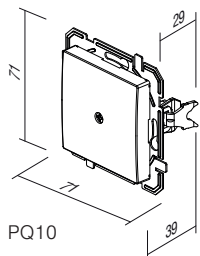

PQ10

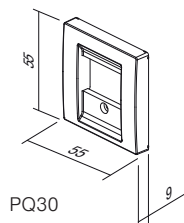

PQ30



OQ10

PW

tip type	naziv description	barva colour
OQ10	OKVIR LOGIQ 1 COVER PLATE LOGIQ 1	PW bela - sijaj polar white
OQ20	OKVIR LOGIQ 2 COVER PLATE LOGIQ 2	TI titan titanium
OQ30	OKVIR LOGIQ 3 COVER PLATE LOGIQ 3	AT antracit anthracite
:	:	
:	:	



- OQ10PW
- OQ10TI
- OQ10AT

OKVIR LOGIQ 1

- dekorativni enojni okvir
- ustreza EN 60669-1

COVER PLATE LOGIQ 1

- decorative cover plate 1-gang
- in accordance with EN 60669-1

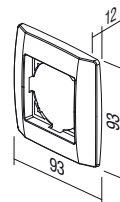

- OQ20PW
- OQ20TI
- OQ20AT

OKVIR LOGIQ 2

- dekorativni dvojni okvir
- ustreza EN 60669-1

COVER PLATE LOGIQ 2

- decorative cover plate 2-gang
- in accordance with EN 60669-1

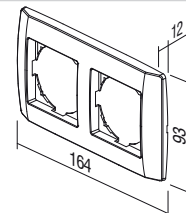



- QQ30PW
- QQ30TI
- QQ30AT

OKVIR LOGIQ 3

- dekorativni trojni okvir
- ustreza EN 60669-1

COVER PLATE LOGIQ 3

- decorative cover plate 3-gang
- in accordance with EN 60669-1

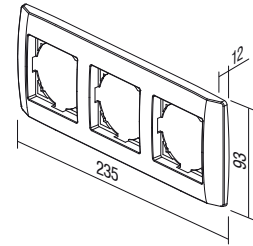

- QQ40PW
- QQ40TI
- QQ40AT

OKVIR LOGIQ 4

- dekorativni četvorni okvir
- ustreza EN 60669-1

COVER PLATE LOGIQ 4

- decorative cover plate 4-gang
- in accordance with EN 60669-1

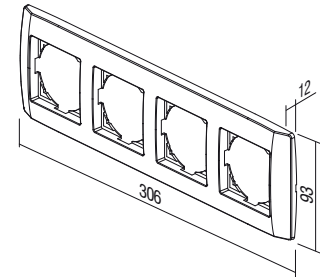

- QQ50PW
- QQ50TI
- QQ50AT

OKVIR LOGIQ 5

- dekorativni 5-mestni okvir
- ustreza EN 60669-1

COVER PLATE LOGIQ 5

- decorative cover plate 5-gang
- in accordance with EN 60669-1

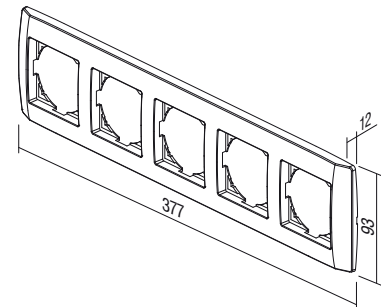

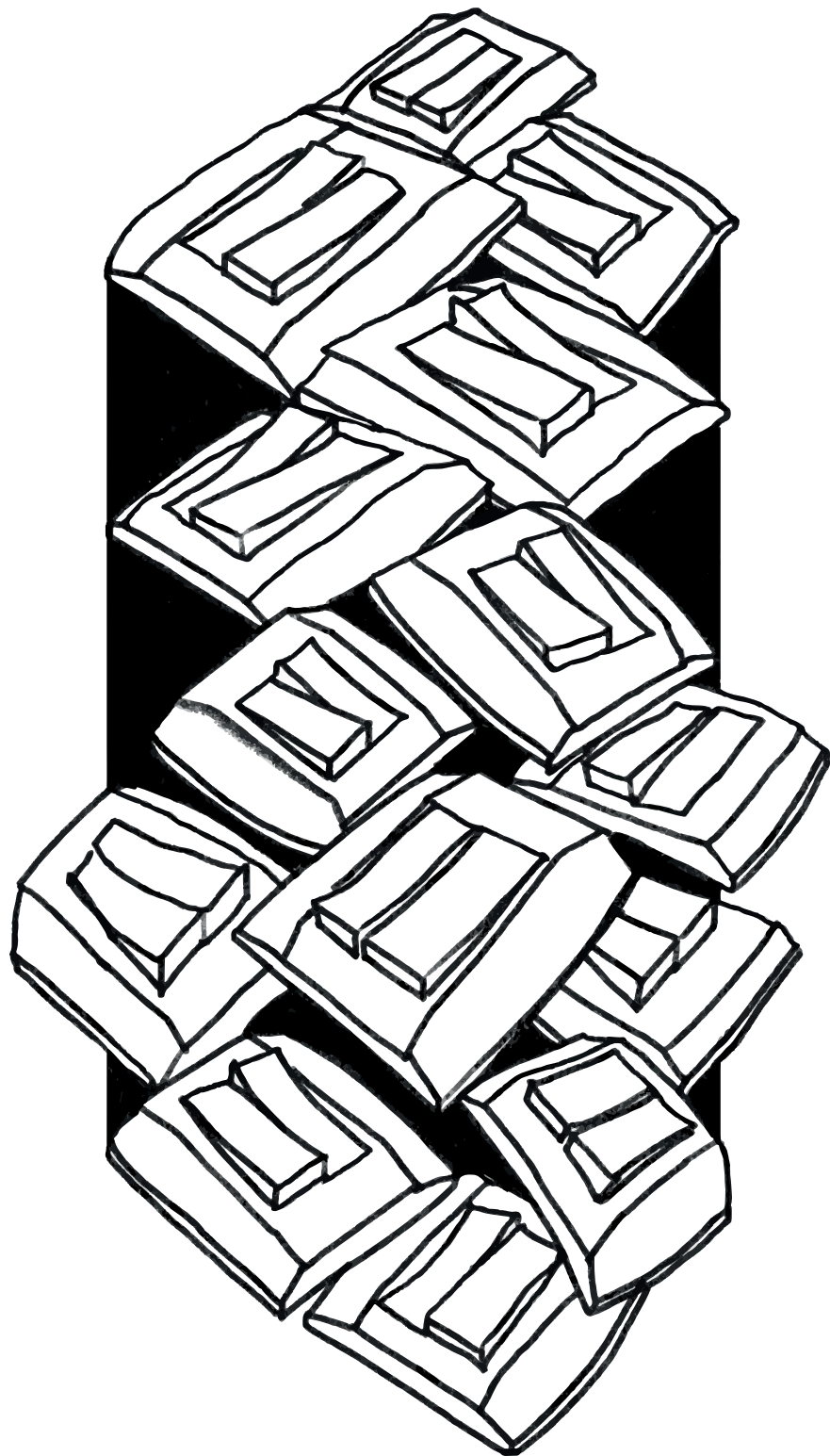

TEM

TEM Čatež d.o.o.
Čatež 13, 8212 Velika Loka
Slovenija
e: info@tem.si
w: www.tem.si
t: +386 (0)7 348 99 00

WJ1220SI-T (18429)
katalog 2023, 1. natis, 06/2023

TEM
WWW.TEM.SI
SLO 2023